

Closed-loop Hall Current Transducer  
TLxx-A3TPV

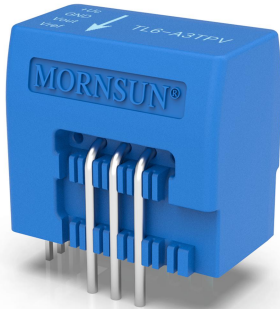

RoHS



**Features**

- Linearity up to 0.1%
- Accuracy up to 0.45%
- Wide frequency bandwidth 200kHz
- Optimized response time 0.4μs
- No insertion losses
- High immunity to external interference
- Complies with UL94V-0 standards

TLxx-A3TPV series Closed-loop Hall Current Transducer ---- is used for isolation measurement between primary and secondary, voltage signal output. It is often used to measure DC, AC, pulse current, etc. Circuit board welded type, the installation is convenient, change the connection mode of one welding pin to change three range, suitable for a variety of occasions.

Application areas: photovoltaic, motor drive, welding power supply, power supply equipment, power heating equipment, large UPS equipment, etc.

**Selection Guide**

Part No.	Input Voltage (VDC)	Primary RMS Current (A)	Primary Current Measurement Range (A)	Rated output voltage(V)	Turns Ratio
TL6-A3TPV	5V	±6	-20 to +20	$V_{ref} \pm 0.625$	1:1600
TL15-A3TPV		±15	-51 to +51		
TL25-A3TPV		±25	-85 to +85		
TL50-A3TPV		±50	-150 to +150		

**Electrical Characteristics**

Item	Operating Conditions	Min	Typ	Max	Unit	
Primary Nominal Rated RMS Current $I_{PN}$ (A)	$T_a=25^{\circ}\text{C}$ , $V_C=5\text{V}$ , $N_p=1$ , $R_L=1\text{k}\Omega$	TL6-A3TPV	--	6	--	A
		TL15-A3TPV	--	15	--	
		TL25-A3TPV	--	25	--	
		TL50-A3TPV	--	50	--	
Primary Current Measurement Range $I_{PM}$ (A)	$T_a=25^{\circ}\text{C}$ , $V_C=5\text{V}$ , $N_p=1$ , $R_L=1\text{k}\Omega$	TL6-A3TPV	-20	--	+20	A
		TL15-A3TPV	-51	--	+51	
		TL25-A3TPV	-85	--	85	
		TL50-A3TPV	-150	--	150	
Supply Voltage $V_C$	$T_a=25^{\circ}\text{C}$	4.75	5	5.25	V	
Number of primary turns $N_p$		1, 2, 3			--	
Conversion Ratio $K_N$	Primary turns=1	1:1600				
Reference voltage $V_{ref}$	$T_a=25^{\circ}\text{C}$ , $@I_p=0\text{A}$	2.495	2.500	2.505	V	
Output voltage $V_{out}@I_p=0\text{A}$	$T_a=25^{\circ}\text{C}$ , $@I_p=0\text{A}$	--	$V_{ref}$	--		
External reference voltage $V_{Eref}$	$T_a=25^{\circ}\text{C}$	0.5	--	2.75		
Rated output voltage $V_{out}@I_{PN}$	$T_a=25^{\circ}\text{C}$ , $@I_p=\pm 6\text{A}$	--	$V_{ref} \pm 0.625$	--		
Current Consumption $I_C$	Primary current $I_p$ , secondary turns $N_s=1600$	--	--	$20.5+(I_p/N_s)$	mA	

**Electrical Characteristics**

Item	Operating Conditions	Min	Typ	Max	Unit
Load resistance $R_L$		1	--	--	k $\Omega$
Temperature coefficient of $V_{out}$ $TCV_{out}$	$T_a = -40^{\circ}C$ to $105^{\circ}C$ , ppm/ $^{\circ}C$ of 2.5V @ $I_p = 0A$	--	--	$\pm 70$	ppm/ $^{\circ}C$
Temperature coefficient of $V_{ref}@I_p=0A$ $TCV_{ref}$	Internal reference	--	$\pm 5$	$\pm 50$	
Temperature coefficient of sensitivity TCS	$T_a = -40^{\circ}C$ to $105^{\circ}C$	--	--	$\pm 40$	

**Dynamic Characteristics**

Item	Operating Conditions	Min	Typ	Max	Unit	
Nominal sensitivity $S_N$	$625mV@I_{PN}$	TL6-A3TPV	--	104.2	--	mV/A
		TL15-A3TPV	--	41.67	--	
		TL25-A3TPV	--	25	--	
		TL50-A3TPV	--	12.5	--	
Linearity Error $\epsilon_L$	$T_a = 25^{\circ}C$ , % of $I_{PN}$	-0.1	--	0.1	%	
Accuracy X	$T_a = 25^{\circ}C$ , % of $I_{PN}$ , $V_{ref} = V_{out}@I_p = 0A$	--	--	0.45		
Accuracy X@ $T_a = 85^{\circ}C(105^{\circ}C)$	$T_a = 85^{\circ}C(105^{\circ}C)$ , % of $I_{PN}$ , $V_{ref} = V_{out}@I_p = 0A$	TL6-A3TPV	--	--		0.75(1)
		TL15-A3TPV	--	--		0.65(0.75)
		TL25-A3TPV	--	--		
		TL50-A3TPV	--	--		
Total accuracy $X_{tot}$	$T_a = 25^{\circ}C$ , % of $I_{PN}$ , $V_{ref} = 2.5V$	TL6-A3TPV	--	--		1.25
		TL15-A3TPV	--	--	0.7	
		TL25-A3TPV	--	--	0.75	
		TL50-A3TPV	--	--	0.65	
Total accuracy $X_{tot}@T_a = 85^{\circ}C(105^{\circ}C)$	$T_a = 85^{\circ}C(105^{\circ}C)$ , % of $I_{PN}$ , $V_{ref} = 2.5V$	TL6-A3TPV	--	--	1.25(1.5)	
		TL15-A3TPV	--	--	0.75(1)	
		TL25-A3TPV	--	--	0.85(0.9)	
		TL50-A3TPV	--	--	0.7(0.8)	
Frequency bandwidth( $\pm 3dB$ )BW	$R_L = 1k\Omega$	--	200	--	kHz	
Delay time $t_{D10}$	$R_L = 1k\Omega$ , $di/dt = 50A/\mu s$ , up to 10% of $I_{PN}$	--	--	0.3	$\mu s$	
Delay time $t_{D90}$	$R_L = 1k\Omega$ , $di/dt = 50A/\mu s$ , up to 90% of $I_{PN}$	--	--	0.4		

**Isolation Characteristics**

Item	Operating Conditions	Min	Typ	Max	Unit
Isolation withstand voltage $V_d$	Primary input, secondary output, 50Hz, 1min, leakage current <1mA.	--	4.5	--	kVAC
Insulation resistance	Primary input, secondary output, 500VDC	--	18	--	G $\Omega$
Creepage distance	Primary input, secondary output	--	7.55	--	mm
Partial discharge test	< 10pC	--	1.65	--	kV
ESD Electrostatic withstand voltage (HBM)		--	--	4	kV
Comparative tracking index (CTI)		--	600	--	V

**General Characteristics**

Item	Min	Typ	Max	Unit
Operating ambient temperature Ta	-40	+25	+105	°C
Storage Environment Temperature T <sub>s</sub>	-55	--	+125	
Weight m	--	10	--	g

**Pin Function**

Pin	Symbol	Function Description
2、3、4	IN	Primary current input pin
7、8、9	OUT	Primary current output pin
11	Vref	Reference voltage pin
12	Vout	Output voltage pin
13	GND	Power supply ground.
14	+Uc	Power supply (V <sub>c</sub> ).

**Product Characteristic Curve**

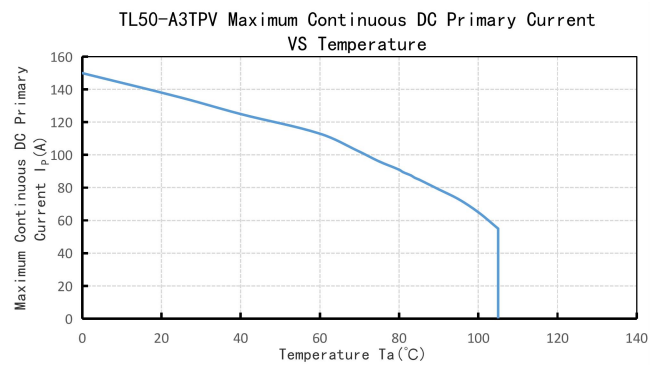
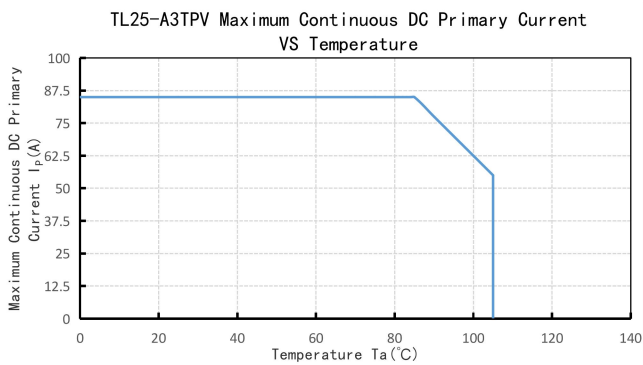
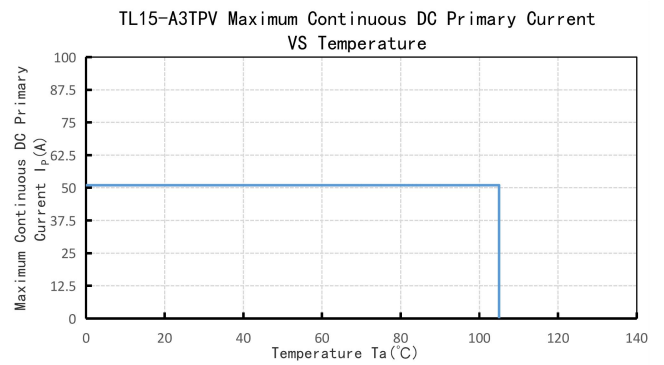
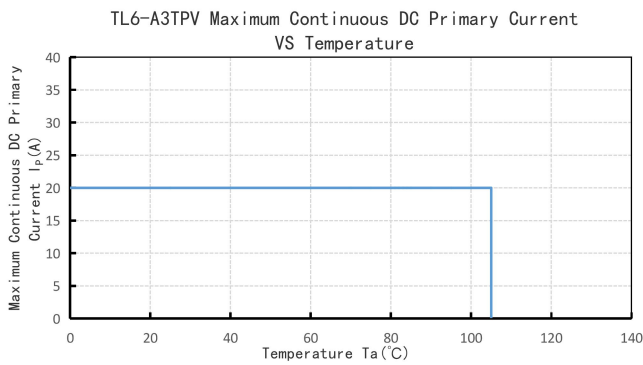

The primary side maximum continuous DC current temperature curve satisfies the following conditions:

- a.  $I_p < I_{PM}$
- b. Junction temperature  $T_j < 130^\circ\text{C}$
- c. Primary conductor temperature  $< 120^\circ\text{C}$

Connection and Description

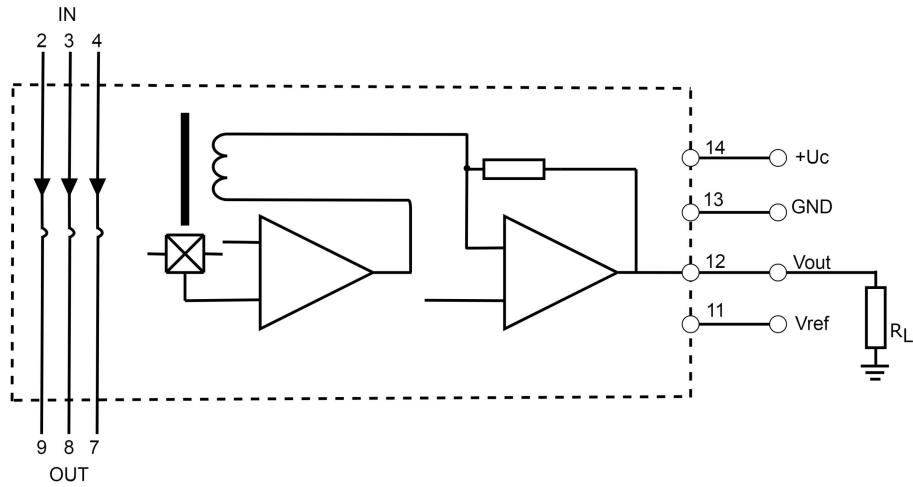

- $I_p$  is measured current. When the detected current is input from pin 2, 3 and 4, it is a forward current. When the detected current is input from pin 7, 8 and 9, it is a reverse current.
- $R_L$  is load resistance, the minimum load resistance is  $1k\Omega$ . If the product is not operated within the required load range, the product performance cannot be guaranteed to comply with all parameters in the datasheet.
- Pin 11 is the reference voltage  $V_{ref}$  detection point, pin 12 is the output voltage  $V_{out}$  detection point.  
 Forward current measurement range:  $V_{out}=V_{ref}+(I_p/I_{PN})*0.625V$ .  
 Reverse current measurement range:  $V_{out}=V_{ref}-(I_p/I_{PN})*0.625V$ .
- The accuracy is defined as the actual zero output voltage  $V_{out}@I_p=0A$ , and the total accuracy is defined as the nominal zero output voltage of 2.5V.
- $V_{ref}$  can be used either as a reference output or as a reference input. When it used as reference voltage output, the current transducer uses the internal reference voltage as the reference point, and the  $V_{ref}$  pin can be unconnected or used as the reference voltage input pin of the back-end sampling circuit. When it used as reference voltage input, the external reference voltage is connected to the  $V_{ref}$  pin, the  $V_{ref}$  pin is not connected. The maximum allowable external reference voltage range is 0.5V to 2.75V.
- When the external reference voltage is used, the external reference voltage source must be able to provide or absorb a certain amount of current I. The measurement range of the external reference voltage and the original side of the current transducer is as follows:

Part No.	External reference voltage source current I(mA)	Primary Current Measurement Range(A)
TL6-A3TPV	$\pm(V_{Eref}-2.5)/150$	Forward current measurement range: $I_p=-9.6*V_{Eref}+45.6A$ ( $V_{Eref}=0.5\sim 2.75V$ ) Reverse current measurement range: $I_p=-9.6*V_{Eref}+2.4A$ ( $V_{Eref}=0.5\sim 2.75V$ )
TL15-A3TPV	$\pm(V_{Eref}-2.5)/150$	Forward current measurement range: $I_p=-24*V_{Eref}+114A$ ( $V_{Eref}=0.5\sim 2.75V$ ) Reverse current measurement range: $I_p=-24*V_{Eref}+6A$ ( $V_{Eref}=0.5\sim 2.75V$ )
TL25-A3TPV	$\pm(V_{Eref}-2.5)/150$	Forward current measurement range: $I_p=-40*V_{Eref}+190A$ ( $V_{Eref}=0.5\sim 2.75V$ ) Reverse current measurement range: $I_p=-40*V_{Eref}+10A$ ( $V_{Eref}=0.5\sim 2.75V$ )
TL50-A3TPV	$\pm(V_{Eref}-2.5)/300$	Forward current measurement range: $I_p=150A$ ( $V_{Eref}=0.5\sim 2.75V$ ) Reverse current measurement range: $I_p=-80*V_{Eref}+20A$ ( $V_{Eref}=0.5\sim 2.75V$ )

- Three different current ranges of the original side can be changed by changing the connection mode of the current input pin of the original side:

Number of primary turns $N_p$	Primary nominal RMS current	Recommended connections	Output voltage $V_{OUT}(V)$
1	$\pm I_{PN}$		$V_{ref} \pm 0.625$
2	$\pm I_{PN}/2$		$V_{ref} \pm 0.625$
3	$\pm I_{PN}/3$		$V_{ref} \pm 0.625$

8. Hot plug is unavailable.

**Dimensions and Recommended**

THIRD ANGLE PROJECTION

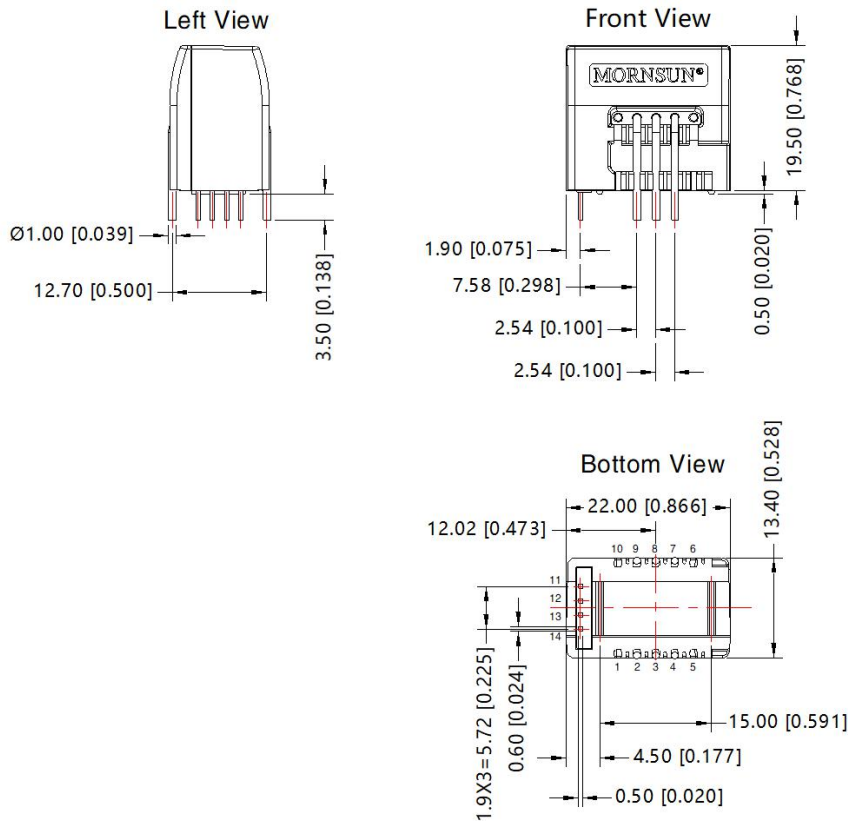

Pin-Out	
Pin	Mark
2	IN
3	IN
4	IN
7	OUT
8	OUT
9	OUT
11	Vref
12	Vout
13	GND
14	+Uc

Note:  
 Unit: mm[inch]  
 Pin diameter tolerances:  $\pm 0.10$  [  $\pm 0.004$  ]  
 General tolerances:  $\pm 0.50$  [  $\pm 0.020$  ]

Notes:

1. For additional information on Product Packaging please refer to [www.mornsun-power.com](http://www.mornsun-power.com). Packaging bag number:58220253;
2. All index testing methods in this datasheet are based on company corporate standards;
3. Unless otherwise specified, parameters in this datasheet were measured under the conditions of Ta=25°C, humidity<75%RH with nominal input voltage.
4. We can provide product customization service, please contact our technicians directly for specific information;
5. This products is used in electronic equipment, please follow the operation and instructions of the manual, and use it in a standard and safe environment;
6. Please do not install the product in a dangerous area; beware of the risk of electric shock during operating, some modules may generate dangerous voltages (such as primary wires, power supply wires);
7. This products is a build-in device, After installation, the conductive part must not be touched completely. A protective box or shield can be used;
8. It is strictly forbidden to disassemble and assemble the products privately to prevent equipment without failure or malfunction;
9. Our products shall be classified according to ISO14001 and related environmental laws and regulations, and shall be handled by qualified units.

**MORNSUN Guangzhou Science & Technology Co., Ltd.**

Address: No. 5, Kehui St. 1, Kehui Development Center, Science Ave., Guangzhou Science City, Huangpu District, Guangzhou, P. R. China

Tel: 86-20-38601850

Fax: 86-20-38601272

E-mail: [info@mornsun.cn](mailto:info@mornsun.cn)

[www.mornsun-power.com](http://www.mornsun-power.com)